

Varenummer: 20479B1816
Beskrivelse: E+G Sensor holder - GN 479-B18-16

Mål

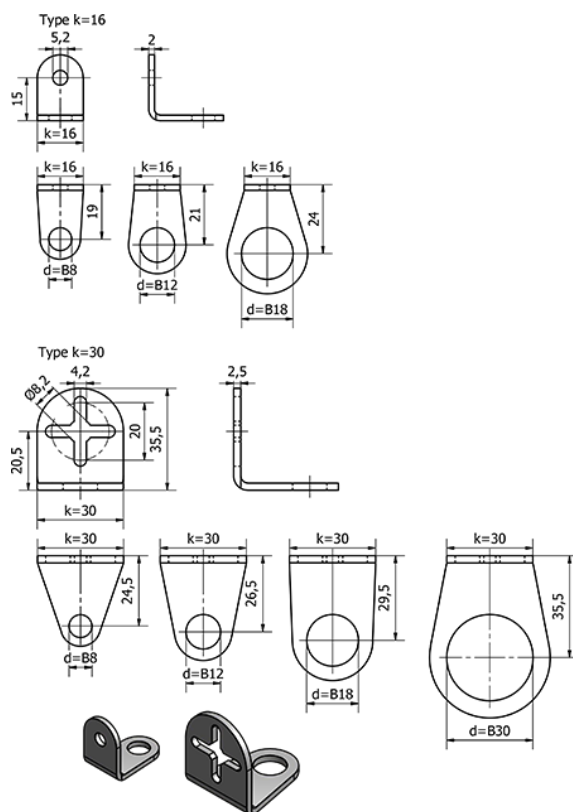

d = 18

k = 16

Vægt (g) = 13